

-1-  M8*45

-2-  M10*60

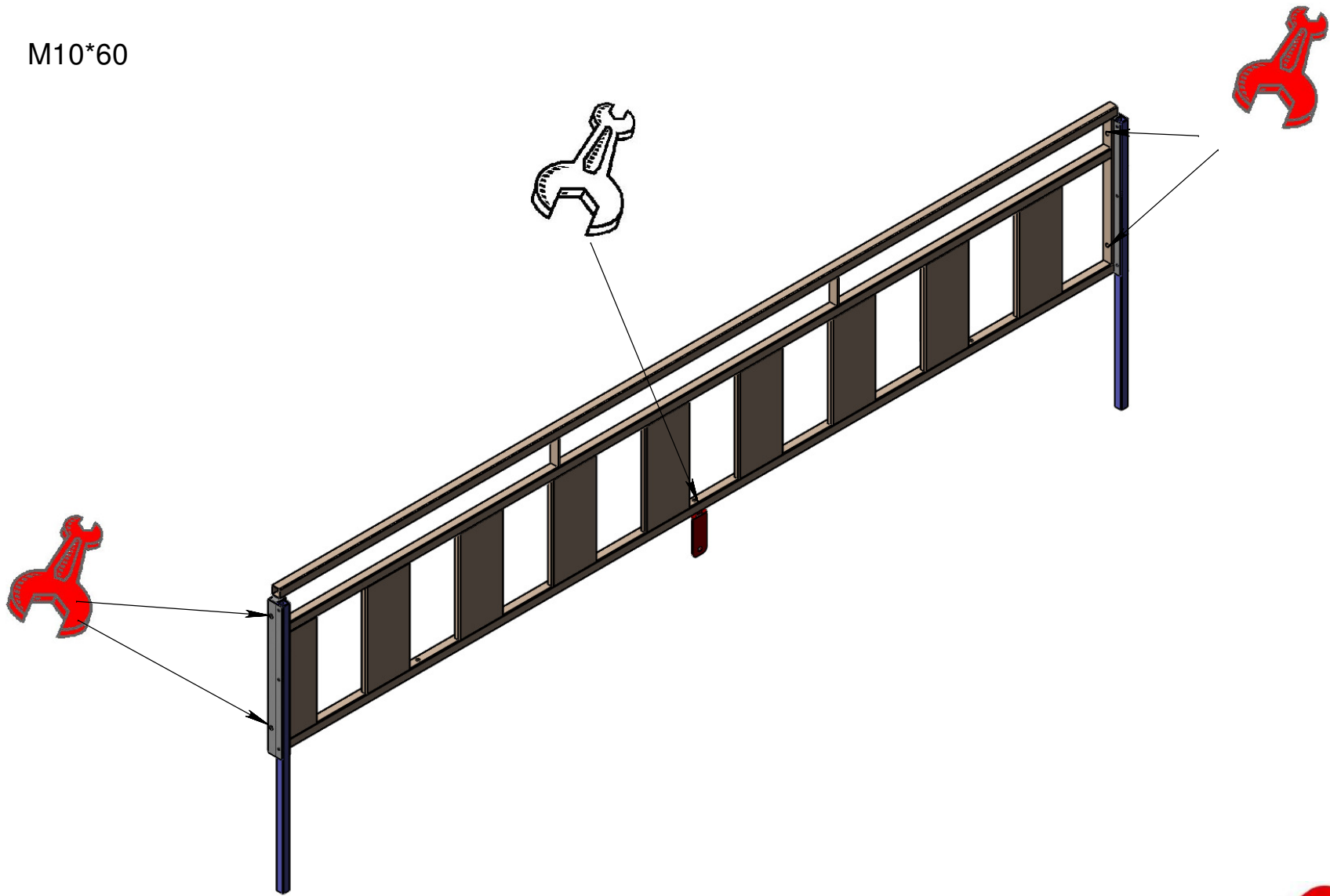
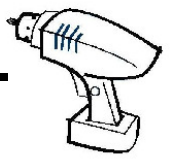
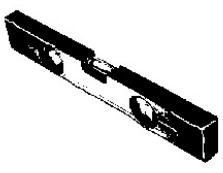

-1-  Ø6.3*19

-2- 

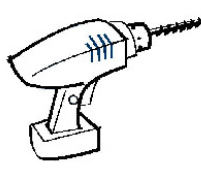
-3-  Ø12

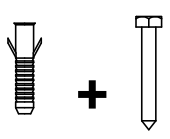
-4- 

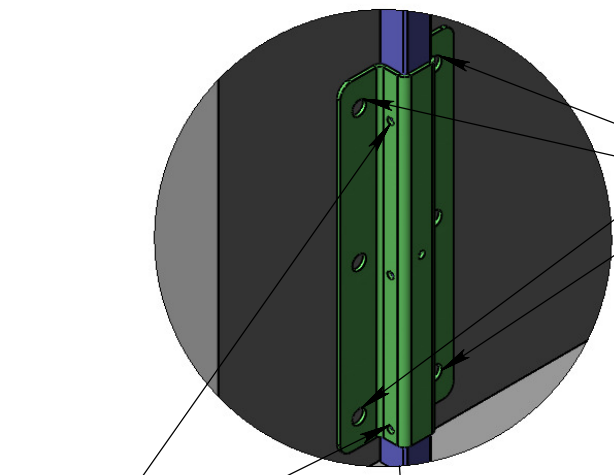

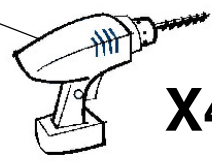
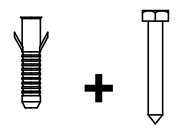
 X4
 X4

 X4

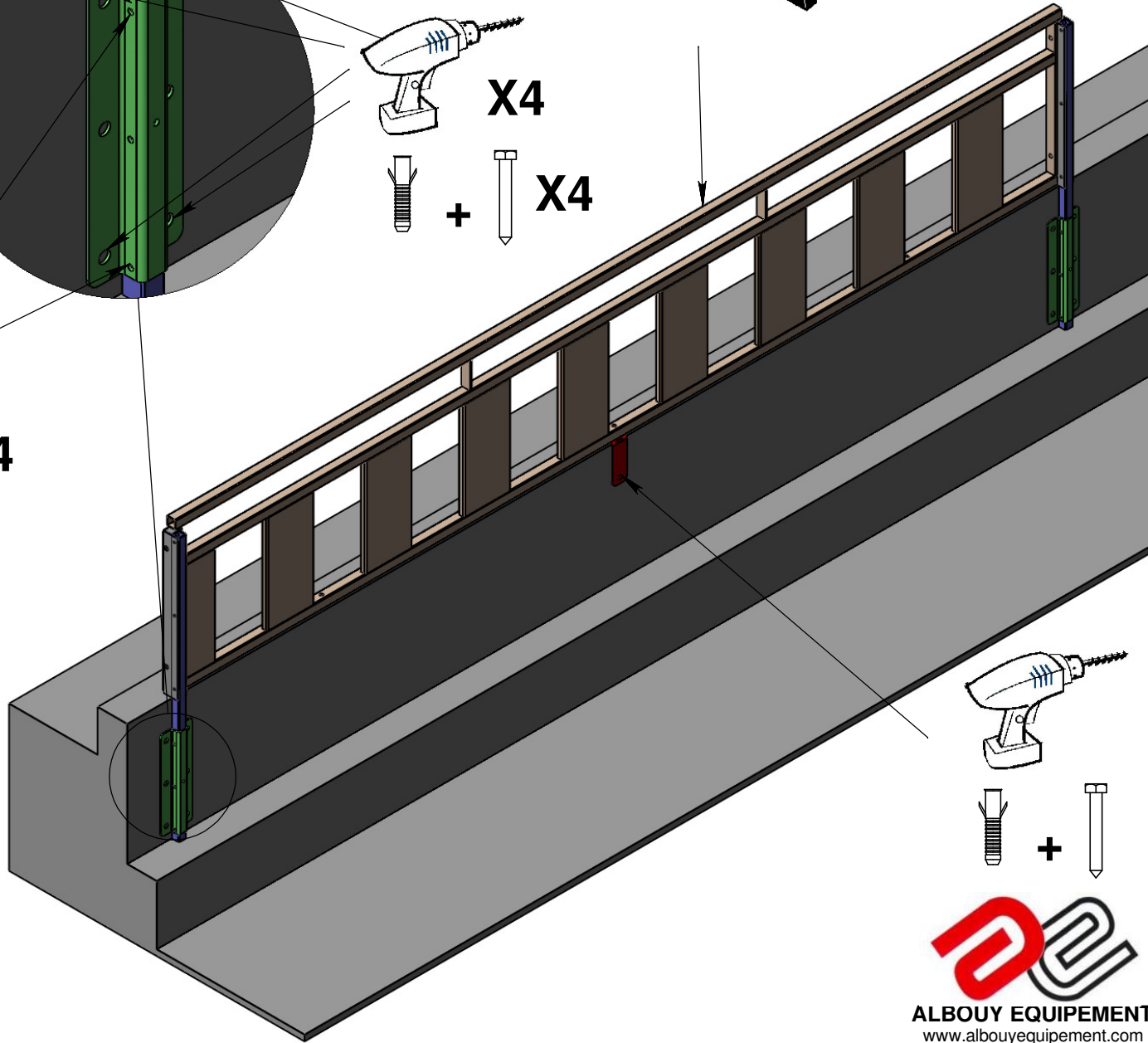

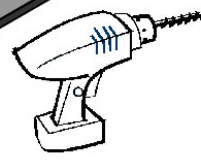
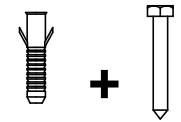



-1-

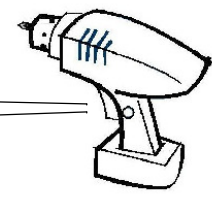
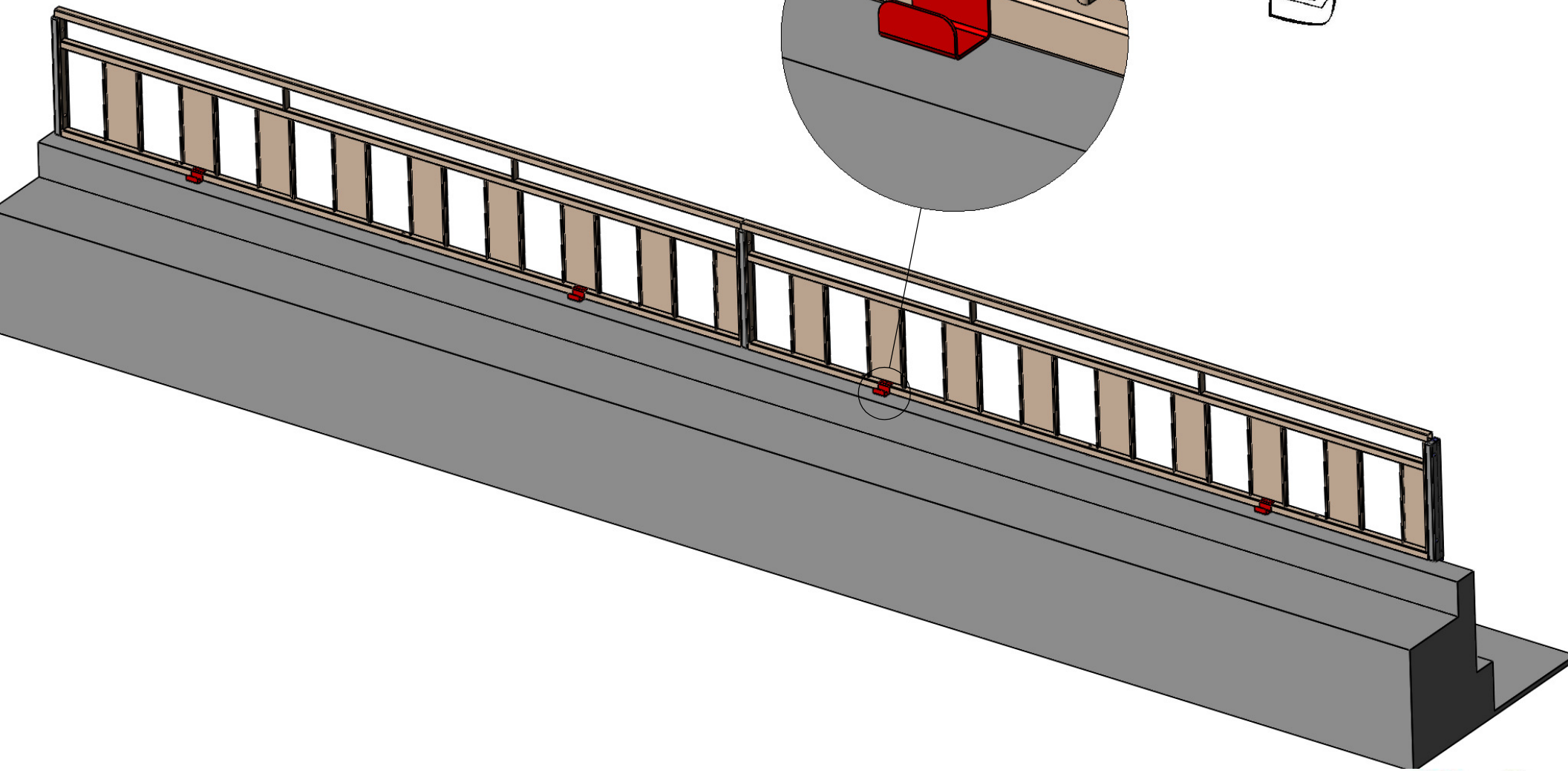

Ø6.3*19



-1- 

-2-  M8*40

-3-  M8*25

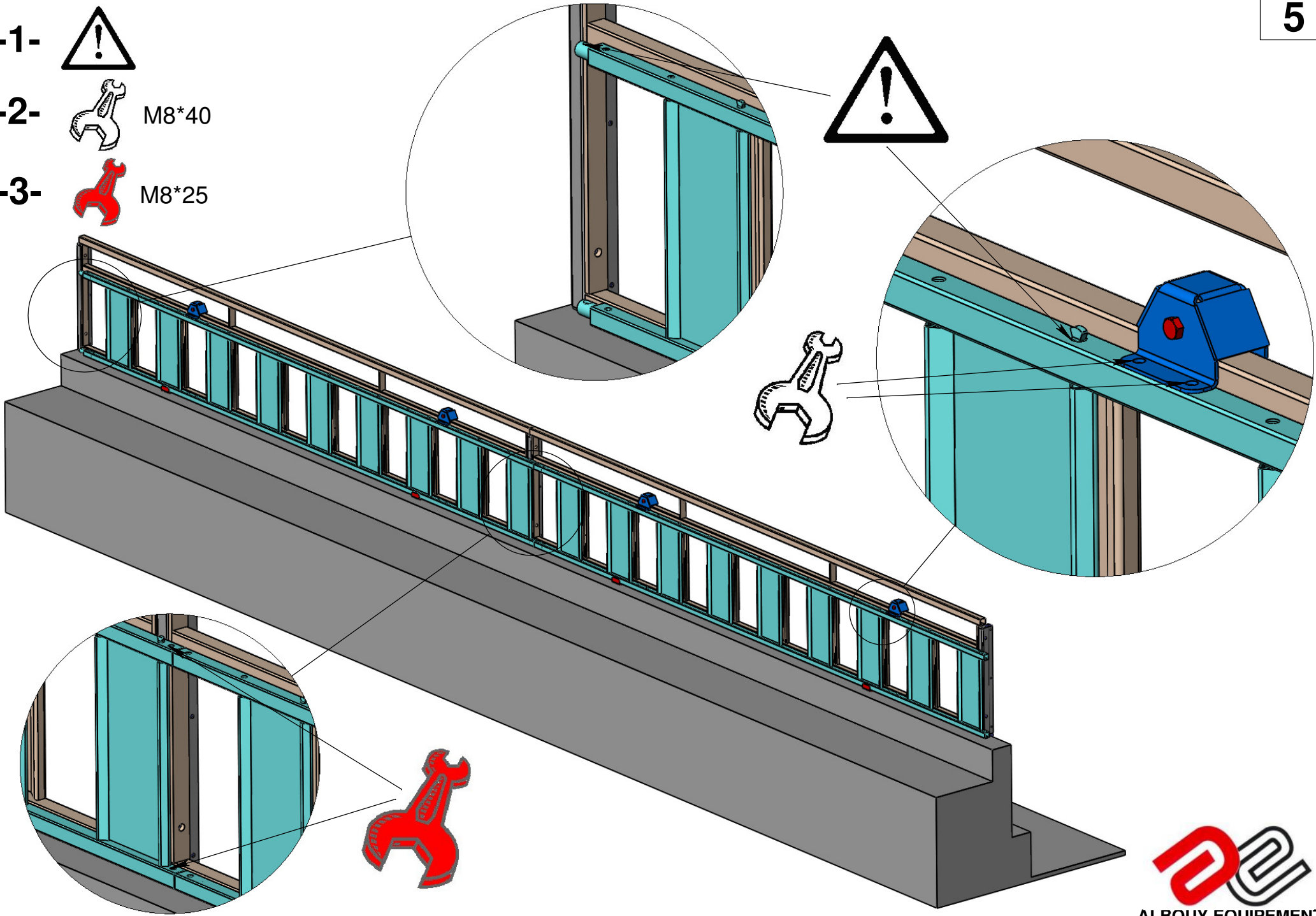

-1-



Ø6.3*32

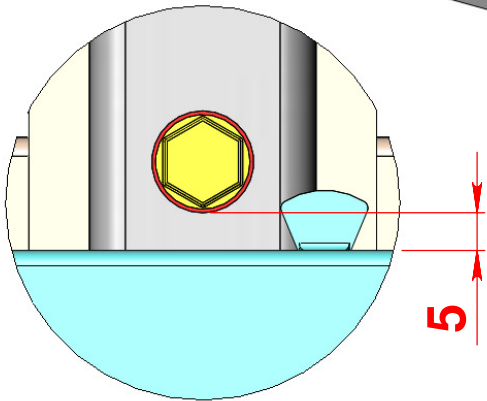
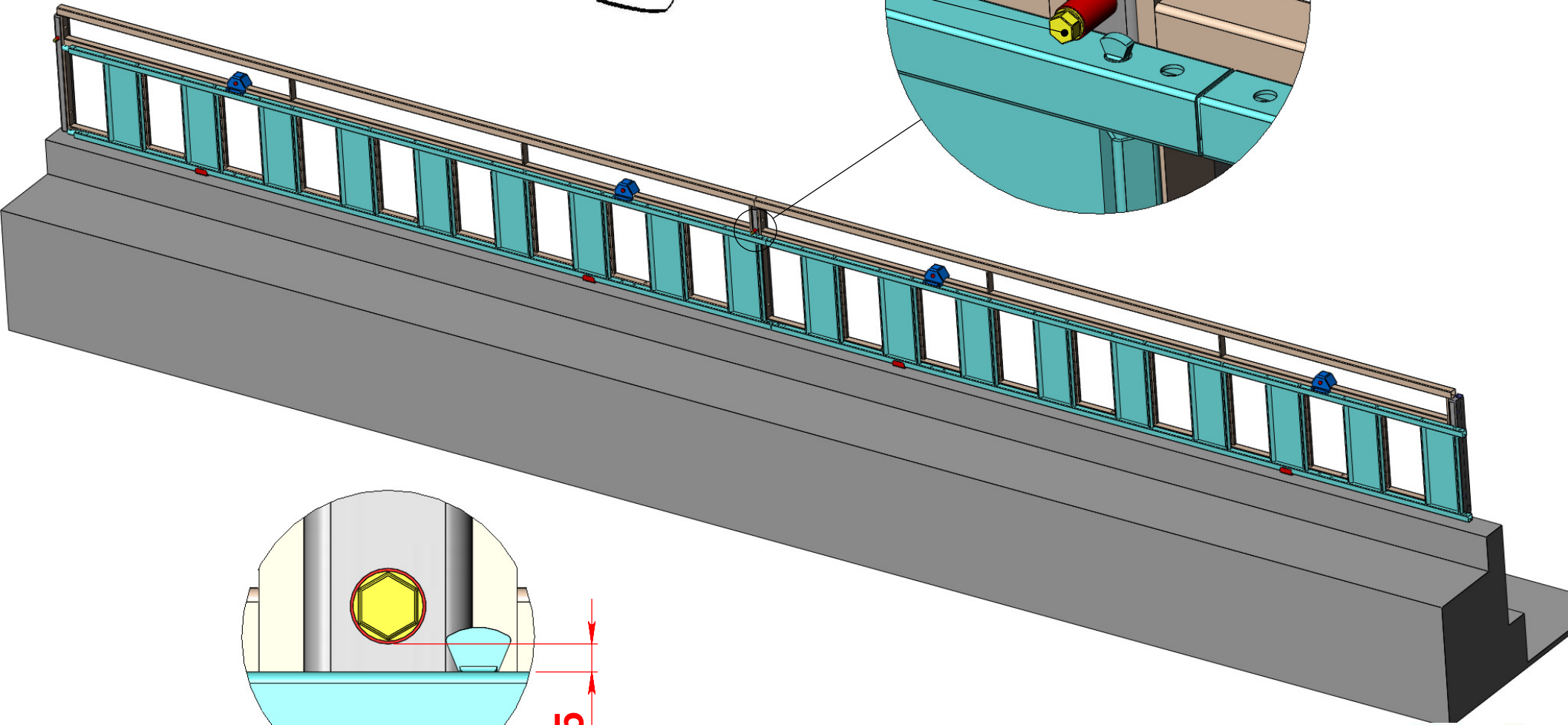
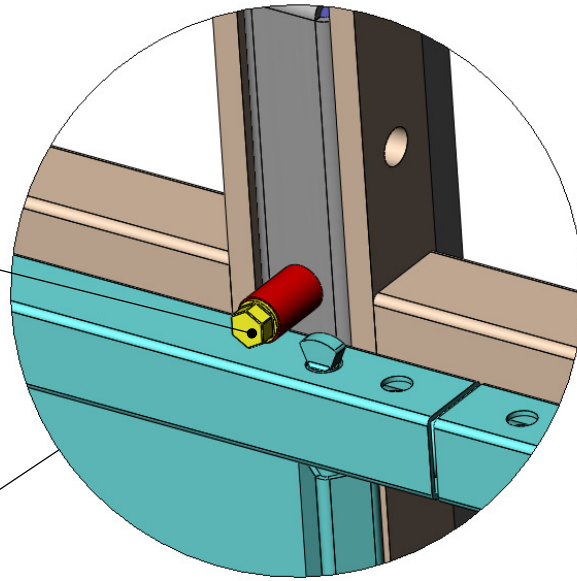
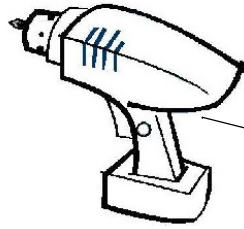

-1-

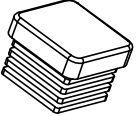

25x25

-2-

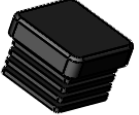

30x30

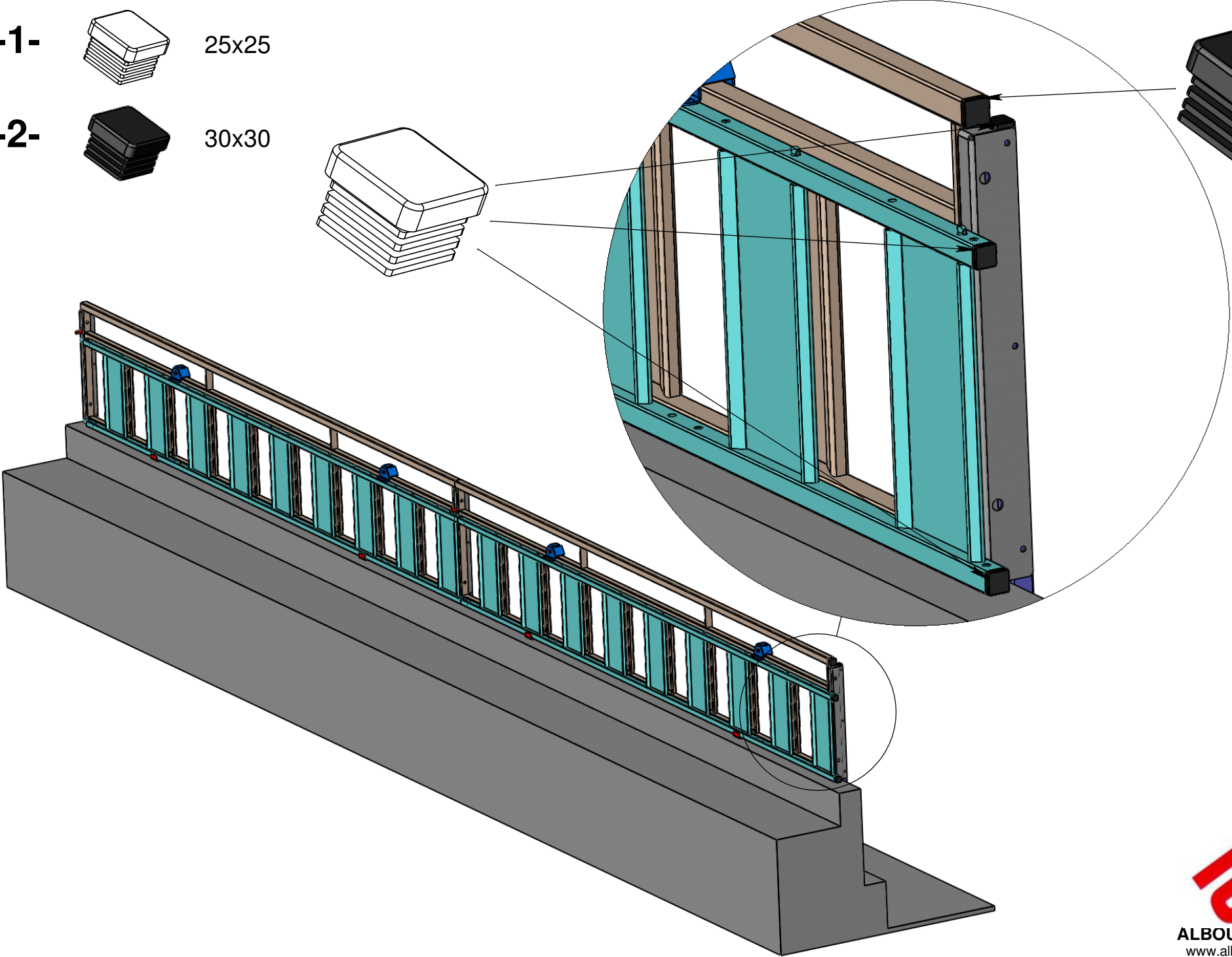
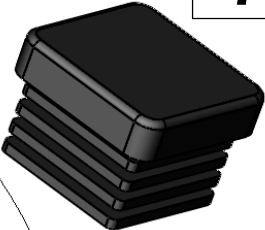
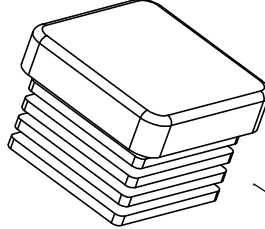

-1-



Ø6.3*32

-2-

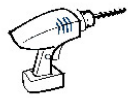

Ø8.5

-3-



M8*50

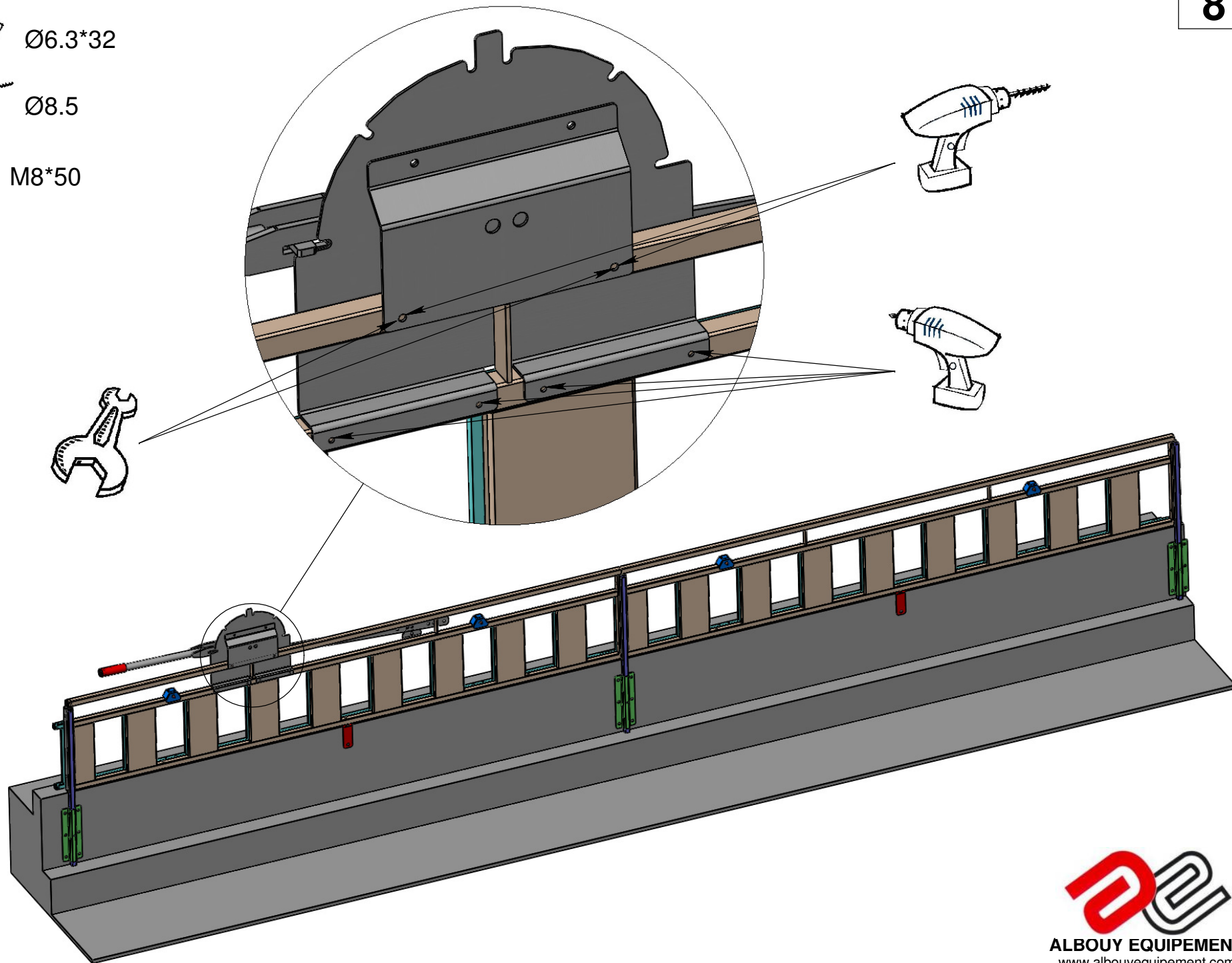

-1-  Ø8.5

-2-  M8*40

